

## 01

## ROUND STONES

Round Stones are loose crystal elements. Most of them are pointed on the reverse side, making them easy to apply in either metal claw settings or pre-set cavities.

The assortment features a wide variety of different cuts and sizes, the most innovative one being the XIRIUS Chaton and the smallest one being the XERO Chaton in size PPO.

The science of the cut and the celebration of crystal as high art come together in the XIRIUS Chaton, Swarovski's most brilliant crystal element ever.

Merging a gemstone-like cut with rich, varied color and Platinum Pro colored foiling for exceptional durability, XIRIUS takes crystal one step closer to the diamond.

COLORS & EFFECTS

OPEN TO SEE COLORS & EFFECTS

**COLORS**



**EFFECTS**

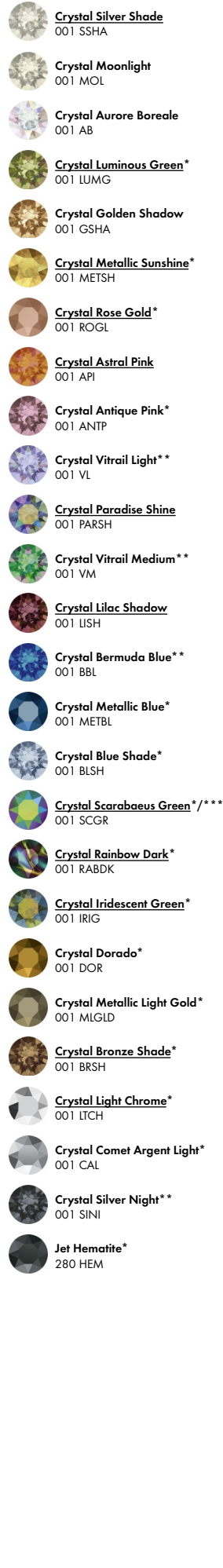

**CRYSTAL LACQUER<sup>PRO</sup>**



**CRYSTAL PATINA**



**NUMERICAL ORDER**

001	Crystal	001 METBL	Crystal Metallic Blue*	215	Black Diamond	283	Provence Lavender
001 AB	Crystal Aurora Boreale	001 METSH	Crystal Metallic Sunshine*	217	Indian Sapphire	284	Greige
001 ANTP	Crystal Antique Pink*	001 MLGLD	Crystal Metallic Light Gold*	220	Smoked Topaz	285	Air Blue Opal
001 API	Crystal Astral Pink	001 MOL	Crystal Moonlight	221	Light Smoked Topaz	288	Dark Indigo
001 BBL	Crystal Bermuda Blue**	001 PARSH	Crystal Paradise Shine	223	Light Rose	289	Indian Pink
001 BLAPA	Crystal Black Patina*	001 RABDK	Crystal Rainbow Dark*	225	Smoky Quartz	291	Fern Green
001 BLSH	Crystal Blue Shade*	001 ROGL	Crystal Rose Gold*	226	Light Topaz	292	Sunflower
001 BRSH	Crystal Bronze Shade*	001 ROSPA	Crystal Rose Patina*	227	Light Siam	319	Vintage Rose
001 CAL	Crystal Comet Argent Light*	001 SCGR	Crystal Scarabaeus Green*/*/*	228	Olivine	327	Indian Siam <sup>1</sup>
001 DOR	Crystal Dorado*	001 SINI	Crystal Silver Night**	229	Blue Zircon	360	Erinite
001 GOLPA	Crystal Gold Patina*	001 SILPA	Crystal Silver Patina*	231	Yellow Opal	361	Light Azore
001 GSHA	Crystal Golden Shadow	001 SSHA	Crystal Silver Shade	234	White Opal	362	Light Peach
001 IRIG	Crystal Iridescent Green*	001 VL	Crystal Vitrail Light**	238	Chrysolite	371	Violet
001 L101	Crystal Powder Yellow*	001 VM	Crystal Vitrail Medium**	243	Capri Blue	379	Indicolite
001 L102	Crystal Powder Green*	001 WHIPA	Crystal White Patina	246	Light Colorado Topaz	383	Light Grey Opal
001 L103	Crystal Powder Rose*	202	Aquamarine	253	Graphite	390	Pacific Opal
001 L104	Crystal Powder Blue*	203	Topaz	257	Blush Rose	391	Silk
001 L105	Crystal Powder Grey*	204	Amethyst	259	Tangerine	395	Rose Water Opal
001 L106S	Crystal Ivory Cream*	205	Emerald	261	Light Silk	398	Cyclamen Opal
001 L107S	Crystal Royal Red*	206	Sapphire	262	Rose Peach	501	Ruby
001 L108S	Crystal Dark Red*	207	Montana	263	Light Turquoise	502	Fuchsia
001 L109S	Crystal Royal Green*	208	Siam	265	Smoky Mauve	515	Burgundy
001 L110S	Crystal Royal Blue*	209	Rose	266	Denim Blue	539	Tanzanite
001 L111S	Crystal Dark Grey*	211	Light Sapphire	267	Turquoise	542	Padparadscha
001 L1SH	Crystal Lilac Shadow	212	Light Amethyst	277	Purple Velvet		
001 LTCH	Crystal Light Chrome*	213	Jonquil	280	Jet		
001 LUMG	Crystal Luminous Green*	214	Peridot	280 HEM	Jet Hematite*		

**ALPHABETICAL ORDER**

<a href="#">Air Blue Opal</a> [285]	<a href="#">Crystal Luminous Green</a> [001 LUMG]*	Emerald [205]	<a href="#">Pacific Opal</a> [390]
<a href="#">Amethyst</a> [204]	<a href="#">Crystal Metallic Blue</a> [001 METBL]*	Erinite [360]	<a href="#">Padparadscha</a> [542]
<a href="#">Aquamarine</a> [202]	<a href="#">Crystal Metallic Light Gold</a> [001 MLGLD]*	<a href="#">Fern Green</a> [291]	<a href="#">Peridot</a> [214]
<a href="#">Black Diamond</a> [215]	<a href="#">Crystal Metallic Sunshine</a> [001 METSH]*	<a href="#">Fuchsia</a> [502]	<a href="#">Provence Lavender</a> [283]
<a href="#">Blue Zircon</a> [229]	<a href="#">Crystal Moonlight</a> [001 MOL]	<a href="#">Greige</a> [284]	<a href="#">Purple Velvet</a> [277]
<a href="#">Blush Rose</a> [257]	<a href="#">Crystal Paradise Shine</a> [001 PARSH]	<a href="#">Graphite</a> [253]	<a href="#">Rose</a> [209]
<a href="#">Burgundy</a> [515]	<a href="#">Crystal Powder Blue</a> [001 L104]*	<a href="#">Indian Pink</a> [289]	<a href="#">Rose Peach</a> [262]
<a href="#">Capri Blue</a> [243]	<a href="#">Crystal Powder Green</a> [001 L102]*	<a href="#">Indian Sapphire</a> [217]	<a href="#">Rose Water Opal</a> [395]
<a href="#">Chrysolite</a> [238]	<a href="#">Crystal Powder Grey</a> [001 L105]*	<a href="#">Indian Siam</a> [327] <sup>1</sup>	<a href="#">Ruby</a> [501]
<a href="#">Crystal</a> [001]	<a href="#">Crystal Powder Rose</a> [001 L103]*	<a href="#">Indicolite</a> [379]	<a href="#">Sapphire</a> [206]
<a href="#">Crystal Antique Pink</a> [001 ANTP]*	<a href="#">Crystal Powder Yellow</a> [001 L101]*	<a href="#">Jet</a> [280]	<a href="#">Siam</a> [208]
<a href="#">Crystal Astral Pink</a> [001 API]	<a href="#">Crystal Rainbow Dark</a> [001 RABDK]*	<a href="#">Jet Hematite</a> [280 HEM]*	<a href="#">Silk</a> [391]
<a href="#">Crystal Aurora Boreale</a> [001 AB]	<a href="#">Crystal Rose Gold</a> [001 ROGL]*	<a href="#">Jonquil</a> [213]	<a href="#">Smoked Topaz</a> [220]
<a href="#">Crystal Bermuda Blue</a> [001 BBL]**	<a href="#">Crystal Rose Patina</a> [001 ROSPA]*	<a href="#">Light Amethyst</a> [212]	<a href="#">Smoky Mauve</a> [265]
<a href="#">Crystal Black Patina</a> [001 BLAPA]*	<a href="#">Crystal Royal Blue</a> [001 L110S]*	<a href="#">Light Azore</a> [361]	<a href="#">Smoky Quartz</a> [225]
<a href="#">Crystal Blue Shade</a> [001 BLSH]*	<a href="#">Crystal Royal Green</a> [001 L109S]*	<a href="#">Light Colorado Topaz</a> [246]	<a href="#">Sunflower</a> [292]
<a href="#">Crystal Bronze Shade</a> [001 BRSH]*	<a href="#">Crystal Royal Red</a> [001 L107S]*	<a href="#">Light Grey Opal</a> [383]	<a href="#">Tangerine</a> [259]
<a href="#">Crystal Comet Argent Light</a> *	<a href="#">Crystal Scarabaeus Green</a> [001 SCGR]*/*/*	<a href="#">Light Peach</a> [362]	<a href="#">Tanzanite</a> [539]
<a href="#">Crystal Dark Grey</a> [001 L111S]*	<a href="#">Crystal Silver Night</a> [001 SINI]**	<a href="#">Light Rose</a> [223]	<a href="#">Topaz</a> [203]
<a href="#">Crystal Dark Red</a> [001 L108S]*	<a href="#">Crystal Silver Patina</a> [001 SILPA]*	<a href="#">Light Sapphire</a> [211]	<a href="#">Turquoise</a> [267]
<a href="#">Crystal Dorado</a> [001 DOR]*	<a href="#">Crystal Silver Shade</a> [001 SSHA]	<a href="#">Light Siam</a> [227]	<a href="#">Vintage Rose</a> [319]
<a href="#">Crystal Golden Shadow</a> [001 GSHA]	<a href="#">Crystal Vitrail Light</a> [001 VL]**	<a href="#">Light Silk</a> [261]	<a href="#">Violet</a> [371]
<a href="#">Crystal Iridescent Green</a> [001 IRIG]*	<a href="#">Crystal Vitrail Medium</a> [001 VM]**	<a href="#">Light Smoked Topaz</a> [221]	<a href="#">White Opal</a> [234]
<a href="#">Crystal Ivory Cream</a> [001 L106S]*	<a href="#">Crystal White Patina</a> [001 WHIPA]	<a href="#">Light Topaz</a> [226]	<a href="#">Yellow Opal</a> [231]
<a href="#">Crystal Light Chrome</a> [001 LTCH]*	<a href="#">Cyclamen Opal</a> [398]	<a href="#">Light Turquoise</a> [263]	
<a href="#">Crystal Lilac Shadow</a> [001 L1SH]	<a href="#">Dark Indigo</a> [288]	<a href="#">Montana</a> [207]	
	<a href="#">Denim Blue</a> [266]	<a href="#">Olivine</a> [228]	

For details on available colors and effects for each article within the product groups, please see the product matrix of the respective item in the Collection 2016.  
For color and effect samples, please see the corresponding color chart.

**Classic Colors/Effects:**  
This color range offers a wide choice of traditional Swarovski crystal colors and effects.

**Exclusive Colors/Effects:**  
This color range is offered exclusively by Swarovski.

The plating resistance of effects is tested according to Swarovski's plating guidelines (SWAROVSKI.COM/PROFESSIONAL). Customers are advised to carry out their own tests if customers' plating parameters diverge from Swarovski plating guidelines.

Colors and effects can appear different when illuminated with different light sources. Swarovski uses standard light source D50 for color decision and comparison. Slight changes in shades are unavoidable. Colors may vary according to cut and foiling.

The composition of Advanced Crystal is compliant with regulatory industry norms and laws regarding the restriction or prohibition of certain substances in the most relevant segments of our customers. Please note that the compliance of the crystal colors Citrine, Fireopal, Hyacinth, Light Siam, Siam and Yellow Opal vary to certain industry regulations. Those regulations are indicated with an (\*) in the compliance overview. Indian Siam (option to Lt. Siam) and Tangerine (option to Sun) conform to all CLEAR-lists.

For further information please visit [swarovski.com/professional](http://swarovski.com/professional)

© 2016 D. Swarovski Distribution GmbH

\* Crystals are not resistant to plating and similar processing.  
\*\* Crystals are resistant to plating only if they are F-failed.  
\*\*\* designed by Jean Paul Gaultier  
<sup>1</sup> The color Indian Siam is available only for a specific size range. Please refer to the current Collection.

## ROUND STONES

# ROUND STONES

## SUMMARY

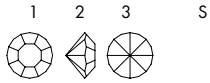

**1100**  
PP 0, 1



**1028**  
PP 2, 3, 4, 5, 6, 7, 8, 9, 10, 11, 12, 13



**1088**  
PP 14, 15, 16, 17, 18, 19, 20, 21, 22,  
23, 24, 25, 26, 27, 28, 29, 30, 31, 32  
SS 18, 19, 20, 21, 22, 24, 26, 28, 29,  
30, 34, 35, 38, 39, 40, 45, 48, 50, 55  
25, 50 mm



**1122**  
SS 17, 24, 29, 34, 39, 47  
12, 14, 16, 18 mm



**1128**  
PP 32  
SS 29, 39



**1188**  
SS 17, 24, 29, 39



**1201**  
27, 35 mm



**1318**  
30, 55 mm



**1357**  
SS 17, 29, 39  
20, 50, 80 mm



**DESIGNER EDITION**  
**1681**  
12, 16 mm



**DESIGNER EDITION**  
**1695**  
10, 14 mm

1 Top view 2 Side view 3 Back view S Setting  
• The logo position is marked by a red dot.

# ROUND STONES

## 1100 XERO Chaton

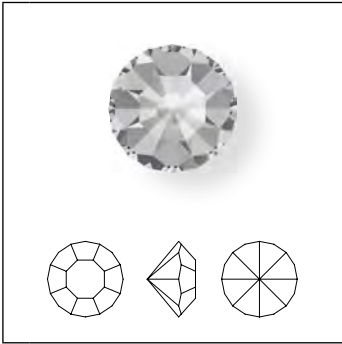

Size

PP 0

PP 1

Crystal		
<input type="checkbox"/>	Crystal F (001)	<input type="checkbox"/>
Colors		
Plain Colors		
<input type="checkbox"/>	Black Diamond F (215)	<input type="checkbox"/>
<input type="checkbox"/>	Jet F (280)	<input type="checkbox"/>
<input type="checkbox"/>	Light Amethyst F (212)	<input type="checkbox"/>
<input type="checkbox"/>	Light Colorado Topaz F (246)	<input type="checkbox"/>
<input type="checkbox"/>	Light Peach F (362)	<input type="checkbox"/>
<input type="checkbox"/>	Light Rose F (223)	<input type="checkbox"/>
<input type="checkbox"/>	Peridot F (214)	<input type="checkbox"/>
<input type="checkbox"/>	Sapphire F (206)	<input type="checkbox"/>
Crystal Effects		
Transparent Effects		
<input type="checkbox"/>	Crystal AB F (001 AB)	<input type="checkbox"/>
<input type="checkbox"/>	Crystal Golden Shadow F (001 GSHA)	<input type="checkbox"/>
<input type="checkbox"/>	Crystal Silver Shade F (001 SSHA)	<input type="checkbox"/>
Color Effects		
Metallic Effects		
<input type="checkbox"/>	Jet Hematite F (280 HEM)	<input type="checkbox"/>

# ROUND STONES

## 1028 XILION Chaton

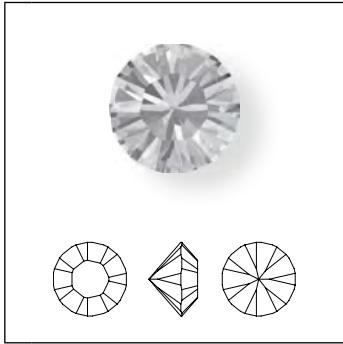

### Crystal

- Crystal (001)
- Crystal F (001)

### Colors

#### Plain Colors

- Amethyst F (204)
- Aquamarine F (202)
- Black Diamond F (215)
- Blue Zircon F (229)
- Blush Rose F (257)
- Burgundy F (515)
- Capri Blue F (243)
- Chrysolite F (238)
- Dark Indigo F (288)
- Denim Blue F (266)
- Emerald F (205)
- Erinte F (360)
- Fern Green F (291)
- Fuchsia F (502)
- Graphite F (253)
- Greige F (284)
- Indian Sapphire F (217)
- Indian Siam F (327)
- Indicolite F (379)
- Jet (280)
- Jet F (280)
- Jonquil F (213)
- Light Amethyst F (212)
- Light Azure F (361)
- Light Colorado Topaz F (246)
- Light Peach F (362)
- Light Rose F (223)
- Light Sapphire F (211)
- Light Siam F (227)
- Light Silk F (261)
- Light Smoked Topaz F (221)
- Light Topaz F (226)
- Light Turquoise F (263)
- Montana F (207)
- Padparadscha F (542)
- Peridot F (214)





Size	PP 2	PP 3	PP 4	PP 5	PP 6	PP 7	PP 8	PP 9	PP 10	PP 11	PP 12	PP 13
Crystal (001)									■	■	■	■
Crystal F (001)	■	■	■	■	■	■	■	■	■	■	■	■
Amethyst F (204)		■	■	■	■	■	■	■	■	■	■	■
Aquamarine F (202)		■	■	■	■	■	■	■	■	■	■	■
Black Diamond F (215)	■	■	■	■	■	■	■	■	■	■	■	■
Blue Zircon F (229)		■	■	■				■	■	■	■	■
Blush Rose F (257)								■	■	■	■	■
Burgundy F (515)								■	■	■	■	■
Capri Blue F (243)								■	■	■	■	■
Chrysolite F (238)		■	■	■				■	■	■	■	■
Dark Indigo F (288)								■	■	■	■	■
Denim Blue F (266)								■	■	■	■	■
Emerald F (205)		■	■	■	■	■	■	■	■	■	■	■
Erinte F (360)		■	■	■				■	■	■	■	■
Fern Green F (291)								■	■	■	■	■
Fuchsia F (502)		■	■	■	■	■	■	■	■	■	■	■
Graphite F (253)			■					■	■	■	■	■
Greige F (284)		■	■	■				■	■	■	■	■
Indian Sapphire F (217)								■	■	■	■	■
Indian Siam F (327)		■	■	■				■	■	■	■	■
Indicolite F (379)		■	■	■				■	■	■	■	■
Jet (280)	■	■	■	■	■	■	■	■	■	■	■	■
Jet F (280)		■	■	■	■	■	■	■	■	■	■	■
Jonquil F (213)		■	■	■	■	■	■	■	■	■	■	■
Light Amethyst F (212)	■	■	■	■	■	■	■	■	■	■	■	■
Light Azure F (361)		■	■	■				■	■	■	■	■
Light Colorado Topaz F (246)	■	■	■	■	■	■	■	■	■	■	■	■
Light Peach F (362)	■	■	■	■	■			■	■	■	■	■
Light Rose F (223)	■	■	■	■	■	■	■	■	■	■	■	■
Light Sapphire F (211)		■	■	■	■	■	■	■	■	■	■	■
Light Siam F (227)		■	■	■	■	■	■	■	■	■	■	■
Light Silk F (261)								■	■	■	■	■
Light Smoked Topaz F (221)		■	■	■	■			■	■	■	■	■
Light Topaz F (226)								■	■	■	■	■
Light Turquoise F (263)								■	■	■	■	■
Montana F (207)		■	■	■	■	■	■	■	■	■	■	■
Padparadscha F (542)		■	■	■				■	■	■	■	■
Peridot F (214)	■	■	■	■	■	■	■	■	■	■	■	■



# ROUND STONES

	Size												
	PP 2	PP 3	PP 4	PP 5	PP 6	PP 7	PP 8	PP 9	PP 10	PP 11	PP 12	PP 13	
<b>1028</b>													
Purple Velvet F (277)								■	■	■		■	
Rose F (209)		■	■	■	■	■	■	■	■	■	■	■	
Ruby F (501)								■	■	■		■	
Sapphire F (206)	■	■	■	■	■	■	■	■	■	■	■	■	
Siam F (208)		■	■	■	■			■	■	■		■	
Silk F (391)		■	■	■				■	■	■		■	
Smoked Topaz F (220)		■	■	■				■	■	■		■	
Smoky Mauve F (265)								■	■	■		■	
Smoky Quartz F (225)		■	■	■				■	■	■		■	
Tangerine F (259)		■						■	■	■		■	
Tanzanite F (539)		■	■	■	■	■	■	■	■	■	■	■	
Topaz F (203)		■	■	■				■	■	■	■	■	
Turquoise (267)								■	■	■		■	
Vintage Rose F (319)		■	■	■	■			■	■	■		■	
Violet F (371)		■	■	■	■	■	■	■	■	■	■	■	
<b>Opal Colors</b>													
Air Blue Opal F (285)								■	■	■		■	
Cyclamen Opal F (398)								■	■	■		■	
Light Grey Opal F (383)								■	■	■		■	
Pacific Opal F (390)								■	■	■		■	
Rose Water Opal F (395)										■		■	
White Opal F (234)		■	■	■				■	■	■		■	
Yellow Opal F (231)								■	■	■		■	
<b>Crystal Effects</b>													
<b>Transparent Effects</b>													
Crystal AB F (001 AB)	■	■	■	■	■	■	■	■	■	■	■	■	
Crystal Antique Pink F (001 ANTP)								■	■	■		■	
Crystal Blue Shade F (001 BLSH)								■	■	■		■	
Crystal Bronze Shade F (001 BRSH)								■	■	■		■	
Crystal Golden Shadow F (001 GSHA)	■	■	■	■				■	■	■		■	
Crystal Lilac Shadow F (001 LISH)								■	■	■		■	
Crystal Luminous Green F (001 LUMG)								■	■	■		■	
Crystal Moonlight F (001 MOL)		■	■	■				■	■	■		■	
Crystal Paradise Shine F (001 PARSH)								■	■	■		■	
Crystal Silver Night F (001 SINI)		■	■	■	■			■	■	■		■	
Crystal Silver Shade F (001 SSHA)	■	■	■	■				■	■	■		■	
<b>Metallic Effects</b>													
Crystal Dorado F (001 DOR)		■	■	■				■	■	■		■	
Crystal Iridescent Green F (001 IRIG)								■	■	■		■	
Crystal Light Chrome F (001 LTCH)								■	■	■		■	
Crystal Metallic Blue F (001 METBL)								■	■	■		■	

ROUND STONES

1028															
		<b>Size</b>													
		PP 2	PP 3	PP 4	PP 5	PP 6	PP 7	PP 8	PP 9	PP 10	PP 11	PP 12	PP 13		
	Crystal Metallic Sunshine F (001 METSH)		■						■	■	■			■	
	Crystal Metallic Light Gold F (001 MLGLD)		■	■	■				■	■	■			■	
	Crystal Rose Gold F (001 ROGL)		■	■	■				■	■	■			■	
<b>Color Effects</b>															
<b>Metallic Effects</b>															
	Jet Hematite (280 HEM)	■	■	■	■	■			■	■	■			■	

# ROUND STONES

## 1088 XIRIUS Chaton

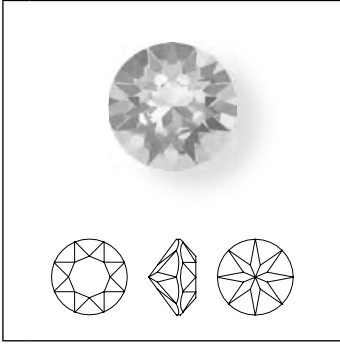

Size

PP 14  
PP 15  
PP 16  
PP 17  
PP 18  
PP 19  
PP 20  
PP 21  
PP 22  
PP 23  
PP 24  
PP 25  
PP 26  
PP 27  
PP 28  
PP 29  
PP 30  
PP 31  
PP 32

Crystal	
<input type="checkbox"/>	Crystal (001)
<input type="checkbox"/>	Crystal F (001)
Colors	
Plain Colors	
<input type="checkbox"/>	Amethyst F (204)
<input type="checkbox"/>	Aquamarine F (202)
<input type="checkbox"/>	Black Diamond F (215)
<input type="checkbox"/>	Blue Zircon F (229)
<input type="checkbox"/>	Blush Rose F (257)
<input type="checkbox"/>	Burgundy F (515)
<input type="checkbox"/>	Capri Blue F (243)
<input type="checkbox"/>	Chrysolite F (238)
<input type="checkbox"/>	Denim Blue F (266)
<input type="checkbox"/>	Emerald F (205)
<input type="checkbox"/>	Erinite F (360)
<input type="checkbox"/>	Fern Green F (291)
<input type="checkbox"/>	Fuchsia F (502)
<input type="checkbox"/>	Graphite F (253)
<input type="checkbox"/>	Greige F (284)
<input type="checkbox"/>	Indian Pink F (289)
<input type="checkbox"/>	Indian Sapphire F (217)
<input type="checkbox"/>	Indicolite F (379)
<input type="checkbox"/>	Jet (280)
<input type="checkbox"/>	Jet F (280)
<input type="checkbox"/>	Jonquil F (213)
<input type="checkbox"/>	Light Amethyst F (212)
<input type="checkbox"/>	Light Azore F (361)
<input type="checkbox"/>	Light Colorado Topaz F (246)
<input type="checkbox"/>	Light Peach F (362)
<input type="checkbox"/>	Light Rose F (223)
<input type="checkbox"/>	Light Sapphire F (211)
<input type="checkbox"/>	Light Siam F (227)
<input type="checkbox"/>	Light Silk F (261)
<input type="checkbox"/>	Light Smoked Topaz F (221)
<input type="checkbox"/>	Light Topaz F (226)
<input type="checkbox"/>	Light Turquoise F (263)
<input type="checkbox"/>	Montana F (207)
<input type="checkbox"/>	Padparadscha F (542)
<input type="checkbox"/>	Peridot F (214)
<input type="checkbox"/>	Provence Lavender F (283)

# ROUND STONES

1088		Size	PP 14	PP 15	PP 16	PP 17	PP 18	PP 19	PP 20	PP 21	PP 22	PP 23	PP 24	PP 25	PP 26	PP 27	PP 28	PP 29	PP 30	PP 31	PP 32
	Rose F (209)		■	■	■	■	■			■			■			■				■	■
	Rose Peach F (262)		■				■			■			■							■	■
	Ruby F (501)		■				■			■			■							■	■
	Sapphire F (206)		■	■	■	■	■			■			■			■				■	■
	Siam F (208)		■				■			■			■			■				■	■
	Silk F (391)		■				■			■			■							■	■
	Smoky Mauve F (265)		■				■			■			■							■	■
	Smoked Topaz F (220)		■				■			■			■			■				■	■
	Smoky Quartz F (225)		■				■			■			■							■	■
	Tangerine F (259)		■				■			■			■							■	■
	Tanzanite F (539)		■				■			■			■							■	■
	Topaz F (203)		■				■			■			■			■				■	■
	Vintage Rose F (319)		■				■			■			■							■	■
	Violet F (371)		■				■			■			■							■	■
<b>Opal Colors</b>																					
	Air Blue Opal F (285)		■				■			■			■							■	■
	Cyclamen Opal F (398)		■				■			■			■							■	■
	Light Grey Opal F (383)		■				■			■			■							■	■
	Pacific Opal F (390)		■				■			■			■							■	■
	Rose Water Opal F (395)		■				■			■			■							■	■
	White Opal F (234)		■				■			■			■							■	■
	Yellow Opal F (231)		■				■			■			■							■	■
<b>Crystal Effects</b>																					
<b>Transparent Effects</b>																					
	Crystal AB F (001 AB)		■	■	■	■	■	■	■	■	■	■	■			■				■	■
	Crystal Antique Pink F (001 ANTP)		■				■			■			■							■	■
	Crystal Blue Shade F (001 BLSH)		■				■			■			■							■	■
	Crystal Golden Shadow F (001 GSHA)		■				■			■			■							■	■
	Crystal Lilac Shadow F (001 LISH)		■				■			■			■							■	■
	Crystal Luminous Green F (001 LUMG)		■				■			■			■							■	■
	Crystal Moonlight F (001 MOL)		■				■			■			■							■	■
	Crystal Paradise Shine F (001 PARSH)		■				■			■			■							■	■
	Crystal Silver Night F (001 SINI)		■				■			■			■							■	■
	Crystal Silver Shade F (001 SSHA)		■				■			■			■							■	■
<b>Metallic Effects</b>																					
	Crystal Dorado F (001 DOR)		■				■			■			■							■	■
	Crystal Iridescent Green F (001 IRIG)		■				■			■			■							■	■
	Crystal Light Chrome F (001 LTCH)		■				■			■			■							■	■
	Crystal Metallic Blue F (001 METBL)		■				■			■			■							■	■
	Crystal Metallic Light Gold F (001 MGLD)		■				■			■			■							■	■
	Crystal Metallic Sunshine F (001 METSH)		■				■			■			■							■	■

# ROUND STONES

	Size	PP 14	PP 15	PP 16	PP 17	PP 18	PP 19	PP 20	PP 21	PP 22	PP 23	PP 24	PP 25	PP 26	PP 27	PP 28	PP 29	PP 30	PP 31	PP 32
<b>1088</b>																				
Crystal Rose Gold F (001 ROGL)		■				■			■			■							■	■
Crystal Scarabaeus Green*** F (001 SCGR)		■				■			■			■								■
<b>Crystal Lacquer<sup>PRO</sup></b>																				
Crystal Powder Blue (001 L104)									■			■								■
Crystal Powder Green (001 L102)									■			■								■
Crystal Powder Grey (001 L105)									■			■								■
Crystal Powder Rose (001 L103)									■			■								■
Crystal Powder Yellow (001 L101)									■			■								■
<b>Crystal Patina Effects</b>																				
Crystal Black Patina F (001 BLAPA)												■								■
Crystal Gold Patina F (001 GOLPA)												■								■
Crystal Rose Patina F (001 ROSPA)												■								■
Crystal Silver Patina F (001 SILPA)												■								■
Crystal White Patina F (001 WHIPA)												■								■
<b>Color Effects</b>																				
<b>Metallic Effects</b>																				
Jet Hematite (280 HEM)		■				■			■			■							■	■

\*\*\* designed by Jean Paul Gaultier

# ROUND STONES

1088		Size	SS 18	SS 19	SS 20	SS 21	SS 22	SS 24	SS 26	SS 28	SS 29	SS 30	SS 34	SS 35	SS 38	SS 39	SS 40	SS 45	SS 48	SS 50	SS 55	25 mm	50 mm
<b>Crystal</b>																							
<input type="checkbox"/>	Crystal (001)		■	■				■			■		■			■							
<input type="checkbox"/>	Crystal F (001)		■	■	■	■	■	■	■	■	■	■	■	■	■	■	■	■	■	■	■	■	■
<b>Colors</b>																							
<b>Plain Colors</b>																							
<input type="checkbox"/>	Amethyst F (204)			■				■			■		■			■		■					
<input type="checkbox"/>	Aquamarine F (202)			■				■			■		■			■		■					
<input type="checkbox"/>	Black Diamond F (215)		■	■				■			■		■			■		■					
<input type="checkbox"/>	Blue Zircon F (229)			■				■			■		■			■							
<input type="checkbox"/>	Blush Rose F (257)							■			■		■			■							
<input type="checkbox"/>	Burgundy F (515)			■				■			■		■			■							
<input type="checkbox"/>	Capri Blue F (243)			■				■			■		■			■							
<input type="checkbox"/>	Chrysolite F (238)			■				■			■		■			■							
<input type="checkbox"/>	Denim Blue F (266)			■				■			■		■			■							
<input type="checkbox"/>	Emerald F (205)			■				■			■		■			■							
<input type="checkbox"/>	Erinite F (360)			■				■			■		■			■							
<input type="checkbox"/>	Fern Green F (291)			■				■			■		■			■							
<input type="checkbox"/>	Fuchsia F (502)			■				■			■		■			■							
<input type="checkbox"/>	Graphite F (253)			■				■			■		■			■							
<input type="checkbox"/>	Greige F (284)			■				■			■		■			■							
<input type="checkbox"/>	Indian Pink F (289)			■				■			■		■			■							
<input type="checkbox"/>	Indian Sapphire F (217)			■				■			■		■			■							
<input type="checkbox"/>	Indicolite F (379)			■				■			■		■			■							
<input type="checkbox"/>	Jet (280)			■				■			■		■			■							
<input type="checkbox"/>	Jonquil F (213)			■				■			■		■			■							
<input type="checkbox"/>	Light Amethyst F (212)			■				■			■		■			■							
<input type="checkbox"/>	Light Azore F (361)			■				■			■		■			■							
<input type="checkbox"/>	Light Colorado Topaz F (246)			■				■			■		■			■			■				
<input type="checkbox"/>	Light Peach F (362)			■				■			■		■			■							
<input type="checkbox"/>	Light Rose F (223)			■				■			■		■			■							
<input type="checkbox"/>	Light Sapphire F (211)			■				■			■		■			■							
<input type="checkbox"/>	Light Siam F (227)			■				■			■		■			■							
<input type="checkbox"/>	Light Silk F (261)			■				■			■		■			■							
<input type="checkbox"/>	Light Smoked Topaz F (221)			■				■			■		■			■							
<input type="checkbox"/>	Light Topaz F (226)			■				■			■		■			■							
<input type="checkbox"/>	Light Turquoise F (263)			■				■			■		■			■							
<input type="checkbox"/>	Montana F (207)			■				■			■		■			■							
<input type="checkbox"/>	Padparadscha F (542)			■				■			■		■			■							
<input type="checkbox"/>	Peridot F (214)			■				■			■		■			■							
<input type="checkbox"/>	Provence Lavender F (283)			■				■			■		■			■							
<input type="checkbox"/>	Rose F (209)			■				■			■		■			■							

# ROUND STONES

	Size	SS 18	SS 19	SS 20	SS 21	SS 22	SS 24	SS 26	SS 28	SS 29	SS 30	SS 34	SS 35	SS 38	SS 39	SS 40	SS 45	SS 48	SS 50	SS 55	25 mm	50 mm	
<b>1088</b>																							
Rose Peach F (262)			■				■			■		■			■								
Ruby F (501)			■				■			■		■			■								
Sapphire F (206)			■				■			■		■			■								
Siam F (208)			■				■			■		■			■		■						
Silk F (391)			■				■			■		■			■								
Smoked Topaz F (220)			■				■			■		■			■								
Smoky Mauve F (265)			■				■			■		■			■								
Smoky Quartz F (225)			■				■			■		■			■								
Tangerine F (259)			■				■			■		■			■								
Tanzanite F (539)			■				■			■		■			■								
Topaz F (203)			■				■			■		■			■								
Vintage Rose F (319)			■				■			■		■			■								
Violet F (371)			■				■			■		■			■								
<b>Opal Colors</b>																							
Air Blue Opal F (285)			■				■			■		■			■								
Cyclamen Opal F (398)			■				■			■		■			■								
Light Grey Opal F (383)			■				■			■		■			■								
Pacific Opal F (390)			■				■			■		■			■								
Rose Water Opal F (395)			■				■			■		■			■								
White Opal F (234)			■				■			■		■			■								
Yellow Opal F (231)			■				■			■		■			■								
<b>Crystal Effects</b>																							
<b>Transparent Effects</b>																							
Crystal AB F (001 AB)		■	■				■			■		■			■								
Crystal Antique Pink F (001 ANTP)			■				■			■		■			■								
Crystal Blue Shade F (001 BLSH)			■				■			■		■			■								
Crystal Golden Shadow F (001 GSHA)			■				■			■		■			■								
Crystal Lilac Shadow F (001 LISH)			■				■			■		■			■								
Crystal Luminous Green F (001 LUMG)			■				■			■		■			■								
Crystal Moonlight F (001 MOL)			■				■			■		■			■								
Crystal Paradise Shine F (001 PARSH)			■				■			■		■			■								
Crystal Silver Night F (001 SINI)			■				■			■		■			■								
Crystal Silver Shade F (001 SSHA)			■				■			■		■			■								
<b>Metallic Effects</b>																							
Crystal Dorado F (001 DOR)			■				■			■		■			■								
Crystal Iridescent Green F (001 IRIG)			■				■			■		■			■								
Crystal Light Chrome F (001 LTCH)			■				■			■		■			■								
Crystal Metallic Blue F (001 METBL)			■				■			■		■			■								
Crystal Metallic Light Gold F (001 MGLD)			■				■			■		■			■								
Crystal Metallic Sunshine F (001 METSH)			■				■			■		■			■								

# ROUND STONES

1088	Size	
	SS 18	SS 19
Crystal Rainbow Dark F (001 RABDK)		
Crystal Rose Gold F (001 ROGL)	■	
Crystal Scarabaeus Green*** F (001 SCGR)		■
<b>Crystal Lacquer<sup>PRO</sup></b>		
Crystal Powder Blue (001 L104)		■
Crystal Powder Green (001 L102)		■
Crystal Powder Grey (001 L105)		■
Crystal Powder Rose (001 L103)		■
Crystal Powder Yellow (001 L101)		■
Crystal Dark Grey (001 L111S)		■
Crystal Dark Red (001 L108S)		■
Crystal Ivory Cream (001 L106S)		■
Crystal Royal Blue (001 L110S)		■
Crystal Royal Green (001 L109S)		■
Crystal Royal Red (001 L107S)		■
<b>Crystal Patina Effects</b>		
Crystal Black Patina F (001 BLAPA)		■
Crystal Gold Patina F (001 GOLPA)		■
Crystal Rose Patina F (001 ROSPA)		■
Crystal Silver Patina F (001 SILPA)		■
Crystal White Patina F (001 WHIPA)		■
<b>Color Effects</b>		
<b>Metallic Effects</b>		
Jet Hematite (280 HEM)	■	■

\*\*\* designed by Jean Paul Gaultier



# ROUND STONES

## 1122 Rivoli

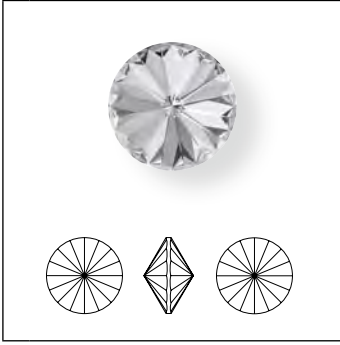

Size	SS 17	SS 24	SS 29	SS 34	SS 39	SS 47	12 mm	14 mm	16 mm	18 mm
------	-------	-------	-------	-------	-------	-------	-------	-------	-------	-------

### Crystal

<input type="checkbox"/> Crystal (001)										
<input type="checkbox"/> Crystal F (001)										

### Colors

#### Plain Colors

<input type="checkbox"/> Amethyst F (204)										
<input type="checkbox"/> Aquamarine F (202)										
<input type="checkbox"/> Black Diamond F (215)										
<input type="checkbox"/> Blush Rose F (257)										
<input type="checkbox"/> Chrysolite F (238)										
<input type="checkbox"/> Denim Blue F (266)										
<input type="checkbox"/> Emerald F (205)										
<input type="checkbox"/> Fuchsia F (502)										
<input type="checkbox"/> Graphite F (253)										
<input type="checkbox"/> Jet (280)										
<input type="checkbox"/> Light Amethyst F (212)										
<input type="checkbox"/> Light Colorado Topaz F (246)										
<input type="checkbox"/> Light Peach F (362)										
<input type="checkbox"/> Light Rose F (223)										
<input type="checkbox"/> Light Sapphire F (211)										
<input type="checkbox"/> Light Siam F (227)										
<input type="checkbox"/> Light Silk F (261)										
<input type="checkbox"/> Light Turquoise F (263)										
<input type="checkbox"/> Montana F (207)										
<input type="checkbox"/> Olivine F (228)										
<input type="checkbox"/> Padparadscha F (542)										
<input type="checkbox"/> Peridot F (214)										
<input type="checkbox"/> Rose F (209)										
<input type="checkbox"/> Rose Peach F (262)										
<input type="checkbox"/> Sapphire F (206)										
<input type="checkbox"/> Siam F (208)										
<input type="checkbox"/> Silk F (391)										
<input type="checkbox"/> Smoked Topaz F (220)										
<input type="checkbox"/> Smoky Mauve F (265)										
<input type="checkbox"/> Sunflower F (292)										
<input type="checkbox"/> Tangerine F (259)										
<input type="checkbox"/> Tanzanite F (539)										
<input type="checkbox"/> Topaz F (203)										
<input type="checkbox"/> Vintage Rose F (319)										
<input type="checkbox"/> Violet F (371)										

# ROUND STONES

1122		Size	SS 17	SS 24	SS 29	SS 34	SS 39	SS 47	12 mm	14 mm	16 mm	18 mm
<b>Opal Colors</b>												
	Yellow Opal F (231)						■	■	■	■		
<b>Crystal Effects</b>												
<b>Transparent Effects</b>												
	Crystal AB F (001 AB)		■	■	■	■	■	■	■	■	■	■
	Crystal Antique Pink F (001 ANTP)					■	■	■	■	■		
	Crystal Blue Shade F (001 BLSH)					■	■	■	■	■		
	Crystal Golden Shadow F (001 GSHA)			■		■	■	■	■	■		■
	Crystal Lilac Shadow F (001 LISH)					■	■	■	■	■		
	Crystal Luminous Green F (001 LUMG)					■	■	■	■	■		
	Crystal Paradise Shine F (001 PARSH)					■	■	■	■	■		
	Crystal Silver Night F (001 SINI)						■	■	■	■		■
	Crystal Silver Shade F (001 SSHA)			■		■	■	■	■	■		■
	Crystal Vitrail Light F (001 VL)			■		■	■	■	■	■		■
	Crystal Vitrail Medium F (001 VM)			■		■	■	■	■	■		■
<b>Metallic Effects</b>												
	Crystal Iridescent Green F (001 IRIG)					■	■	■	■	■		■
	Crystal Metallic Sunshine F (001 METSH)					■	■	■	■	■		
	Crystal Rainbow Dark F (001 RABDK)			■		■	■	■	■	■		
	Crystal Rose Gold F (001 ROGL)					■	■	■	■	■		
	Crystal Scarabaeus Green*** F (001 SCGR)					■	■	■	■	■		
<b>Crystal Patina Effects</b>												
	Crystal Black Patina F (001 BLAPA)					■	■	■	■	■		
	Crystal Gold Patina F (001 GOLPA)					■	■	■	■	■		
	Crystal Rose Patina F (001 ROSPA)					■	■	■	■	■		
	Crystal Silver Patina F (001 SILPA)					■	■	■	■	■		
	Crystal White Patina F (001 WHIPA)					■	■	■	■	■		
<b>Crystal Lacquer<sup>PRO</sup></b>												
	Crystal Dark Grey (001 L111S)							■	■	■		
	Crystal Dark Red (001 L108S)							■	■	■		
	Crystal Ivory Cream (001 L106S)							■	■	■		
	Crystal Royal Blue (001 L110S)							■	■	■		
	Crystal Royal Green (001 L109S)							■	■	■		
	Crystal Royal Red (001 L107S)							■	■	■		
<b>Color Effects</b>												
<b>Metallic Effects</b>												
	Jet Hematite (280 HEM)			■		■	■	■	■	■		

\*\*\* designed by Jean Paul Gaultier

ROUND STONES

1128

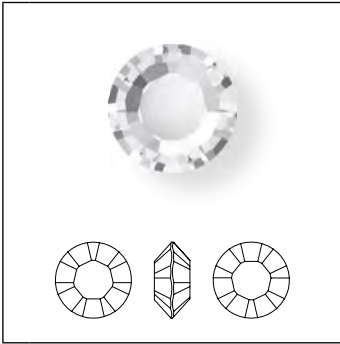

Size	PP 32	SS 29	SS 39
------	-------	-------	-------

- Crystal**
- Crystal (001)
- Colors**
- Plain Colors**
- Amethyst (204)
- Emerald (205)
- Light Amethyst (212)
- Light Sapphire (211)
- Peridot (214)
- Rose (209)
- Sapphire (206)
- Siam (208)
- Topaz (203)

1188 XIRIUS Pointed Chaton

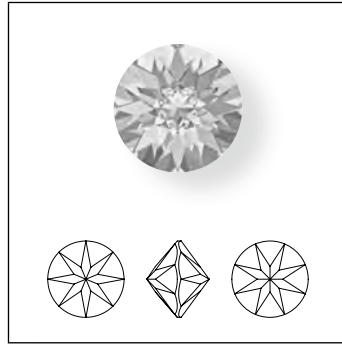

Size	SS 17	SS 24	SS 29	SS 39
------	-------	-------	-------	-------

- Crystal**
- Crystal (001)
- Crystal F (001)
- Colors**
- Plain Colors**
- Aquamarine F (202)
- Black Diamond F (215)
- Jet (280)
- Light Peach F (362)
- Light Rose F (223)
- Light Siam F (227)
- Montana F (207)
- Rose F (209)
- Crystal Effects**
- Transparent Effects**
- Crystal AB F (001 AB)
- Crystal Golden Shadow F (001 GSHA)
- Crystal Lilac Shadow F (001 LISH)
- Crystal Luminous Green F (001 LUMG)
- Crystal Silver Shade F (001 SSHA)
- Metallic Effects**
- Crystal Iridescent Green F (001 IRIG)
- Crystal Rose Gold F (001 ROGL)
- Crystal Patina Effects**
- Crystal Black Patina F (001 BLAPA)
- Crystal Gold Patina F (001 GOLPA)
- Crystal Rose Patina F (001 ROSPA)
- Crystal Silver Patina F (001 SILPA)
- Crystal White Patina F (001 WHIPA)

# ROUND STONES

## 1201

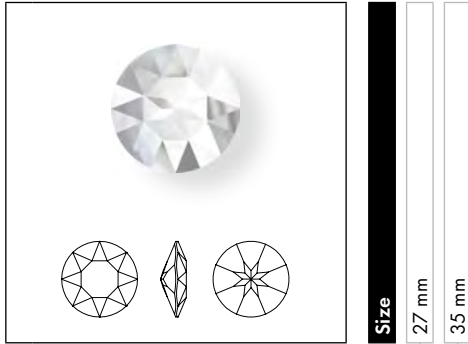

**Size**  
27 mm  
35 mm

### Crystal

- Crystal (001)
- Crystal F (001)

### Colors

#### Plain Colors

- Aquamarine F (202)

### Crystal Effects

#### Transparent Effects

- Crystal AB F (001 AB)

## 1318 Flower Cut

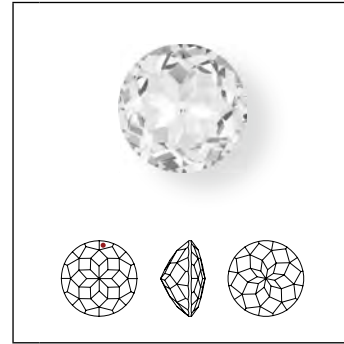

**Size**  
30 mm  
55 mm

### Crystal

- Crystal CAL V SI (001 CAL V SI) <sup>1</sup>

## 1357 Brilliant Cut

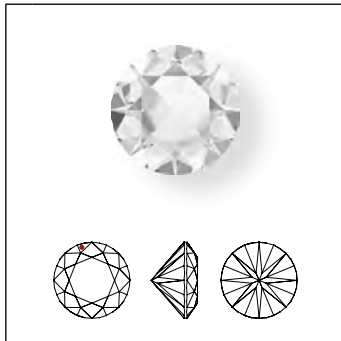

**Size**  
SS 17  
SS 29  
SS 39  
20 mm  
50 mm  
80 mm

### Crystal

- Crystal (001)
- Crystal F (001)
- Crystal CAL V SI (001 CAL V SI) <sup>1</sup>

<sup>1</sup> These articles are delivered with a laser-engraved logo.  
• The logo position is marked by a red dot.

# ROUND STONES

**DESIGNER EDITION**

ATELIER MUNSTEINER FOR SWAROVSKI

## Vision Round Stone

The new Vision Designer Edition marks the first ever collaboration between Swarovski and Atelier Munsteiner, a German design house renowned for its multi-award-winning gemstone cuts, fine jewelry, and sculptures. The family-owned company's third-generation master craftsmen have drawn upon many years of experience to develop this stunning crystal innovation exclusively for Swarovski.

The Vision Designer Edition combines the uncomplicated appeal of simple cuts with the playfulness of mirrored reflections. These ingeniously crafted design elements

bring to mind frozen water, with mysteriously encapsulated air bubbles forming a perfectly geometrical, flower-like shape within the crystal. It is available in three of the most popular shapes for Jewelry and Accessories – the round, square, and hexagon – offering endless design possibilities and making it ideal for use in Glamorous and Progressive creations.

It's the subtlety in the simplicity that makes this Designer Edition truly "VISIONARY."

### 1681 Vision Round Stone

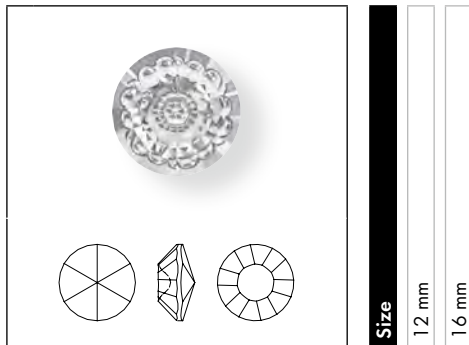

**Size**  
12 mm  
16 mm

Crystal	12 mm	16 mm
Crystal F (001)	■	■
Colors		
Plain Colors		
Aquamarine F (202)	■	■
Erinite F (360)	■	■
Light Colorado Topaz F (246)	■	■
Light Peach F (362)	■	■
Light Siam F (227)	■	■
Rose F (209)	■	■
Smoky Mauve F (265)	■	■
Tanzanite F (539)	■	■
Crystal Effects		
Transparent Effects		
Crystal Antique Pink F (001 ANTP)	■	■
Crystal Astral Pink F (001 API)	■	■
Crystal Blue Shade F (001 BLSH)	■	■
Crystal Golden Shadow F (001 GSHA)	■	■
Crystal Luminous Green F (001 LUMG)	■	■
Crystal Silver Night F (001 SINI)	■	■

### 1681/S

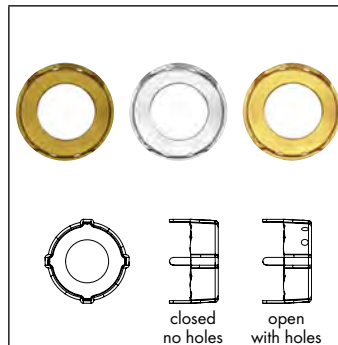

**Size & color of plating**  
12 mm Unplated  
16 mm Unplated  
12 mm Rhodium  
16 mm Rhodium  
12 mm Gold  
16 mm Gold

Ring/Hole, Back Configuration	12 mm Unplated	16 mm Unplated	12 mm Rhodium	16 mm Rhodium	12 mm Gold	16 mm Gold
00 C = No ring/hole, closed	■	■				
H2 O = 4 holes/2 each side, open			■	■	■	■

# ROUND STONES

**DESIGNER EDITION**

## THE VISION DESIGNER EDITION FAMILY



**1681**  
12, 16 mm

chapter 01 Round Stones  
p. 84



**4681**  
14, 18 mm

chapter 02 Fancy Stones & Settings  
p. 140



**1681/S**  
12, 16 mm

chapter 01 Round Stones  
p. 84



**4681/S**  
14, 18 mm

chapter 02 Fancy Stones & Settings  
p. 140



**4481**  
12, 16 mm

chapter 02 Fancy Stones & Settings  
p. 125



**4481/S**  
12, 16 mm

chapter 02 Fancy Stones & Settings  
p. 125

## DESIGNER EDITIONS - DISTINCT PACKAGING

This Designer Edition will be labelled with the  
"Designer Edition" imprint directly on the packaging.

# ROUND STONES

**DESIGNER EDITION**

OCEAN MYSTERIES DESIGNED  
BY CÉLINE COUSTEAU

**Design Story:** A love for the sea runs through her veins: Céline Cousteau is a celebrated filmmaker, humanitarian, and environmentalist, and, as it so happens, the granddaughter of legendary ocean explorer Jacques Yves Cousteau. She presents her first ever crystal designs for Swarovski, inspired by one of her favorite places, the depths of the ocean. Taking inspiration from nature itself

and leaving its beauty unaltered, her stunningly life-like creatures are not only captivating and spellbinding, they also draw attention toward the mysterious, mostly unseen, and unexplored world beneath the ocean's surface on which all ocean life depends. These mysteries need to be protected for future generations, both above and below the water.

## 1695 Sea Urchin Round Stone partly frosted

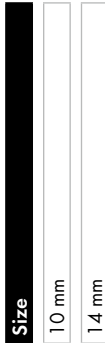
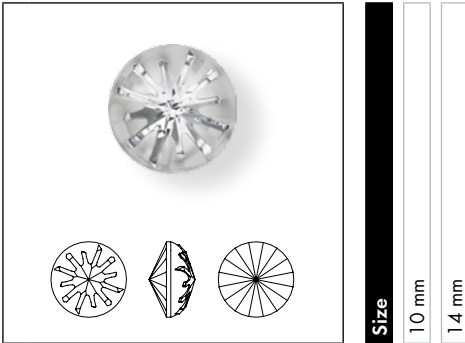

Crystal	
Crystal F (001)	<input type="checkbox"/> <input type="checkbox"/>
Colors	
Plain Colors	
Blush Rose F (257)	<input type="checkbox"/> <input type="checkbox"/>
Tanzanite F (539)	<input type="checkbox"/> <input type="checkbox"/>
Opal Colors	
White Opal F (234)	<input type="checkbox"/> <input type="checkbox"/>
Crystal Effects	
Transparent Effects	
Crystal AB F (001 AB)	<input type="checkbox"/> <input type="checkbox"/>
Crystal Bermuda Blue F (001 BBL)	<input type="checkbox"/> <input type="checkbox"/>
Crystal Blue Shade F (001 BLSH)	<input type="checkbox"/> <input type="checkbox"/>
Crystal Golden Shadow F (001 GSHA)	<input type="checkbox"/> <input type="checkbox"/>
Crystal Luminous Green F (001 LUMG)	<input type="checkbox"/> <input type="checkbox"/>
Crystal Silver Night (001 SINI)	<input type="checkbox"/> <input type="checkbox"/>
Crystal Silver Shade F (001 SSHA)	<input type="checkbox"/> <input type="checkbox"/>

## 1695/S

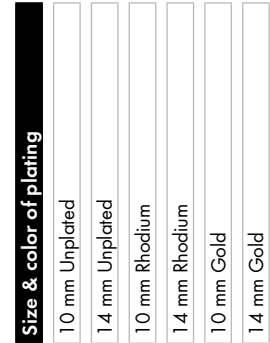
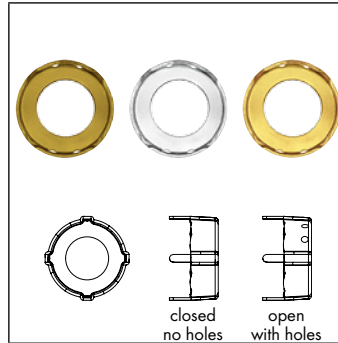

Ring/Hole, Back Configuration	
00 C = No ring/hole, closed	<input type="checkbox"/> <input type="checkbox"/>
H2 O = 4 holes/2 each side, open	<input type="checkbox"/> <input type="checkbox"/> <input type="checkbox"/> <input type="checkbox"/>

# ROUND STONES

**DESIGNER EDITION**

## THE CÉLINE COUSTEAU DESIGNER EDITION FAMILY



**1695** chapter 01 Round Stones  
10, 14 mm p. 86



**1695/S** chapter 01 Round Stones  
10, 14 mm p. 86



**2612** chapter 07 Flat Backs No Hotfix  
6, 10, 14 mm p. 360



**2612** chapter 08 Flat Backs Hotfix  
6, 10, 14 mm p. 396



**4195** chapter 02 Fancy Stones & Settings  
14, 18, 22 mm p. 103



**4195/S** chapter 02 Fancy Stones & Settings  
14, 18, 22 mm p. 103



**6730** chapter 06 Pendants  
18x11.5, 34x22 mm p. 321



**6731** chapter 06 Pendants  
14, 28 mm p. 322

## DESIGNER EDITIONS - DISTINCT PACKAGING

This Designer Edition will be labelled with the  
"Designer Edition" imprint directly on the packaging.



## ROUND STONES

## PRODUCT DETAILS

Article Size	Packing Unit = Minimum Order Quantity in Pieces	Average Net Weight in Grams per Packing Unit Crystal (001)	Average Gross Weight in Grams per Packing Unit Crystal (001)
<b>1100</b>			
PP 0	1,440	0.4	9.0
PP 1	1,440	0.6	9.1
<b>1028</b>			
PP 2	1,440	0.7	11.6
PP 3	1,440	1.1	11.8
PP 4	1,440	1.4	12.2
PP 5	1,440	1.8	12.6
PP 6	1,440	2.1	13.3
PP 7	1,440	2.3	13.6
PP 8	1,440	2.8	14.8
PP 9	1,440	3.4	17.7
PP 10	1,440	3.8	15.2
PP 11	1,440	4.7	16.4
PP 12	1,440	5.6	17.5
PP 13	1,440	6.7	19.2
<b>1088</b>			
PP 14	1,440	7.1	18.1
PP 15	1,440	7.3	19.5
PP 16	1,440	8.5	21.0
PP 17	1,440	9.0	22.4
PP 18	1,440	12.0	23.8
PP 19	1,440	12.1	25.3
PP 20	1,440	14.6	28.2
PP 21	1,440	15.8	29.6
PP 22	1,440	16.9	31.0
PP 23	1,440	19.6	33.9
PP 24	1,440	24.4	36.8
PP 25	1,440	25.4	41.1
PP 26	1,440	27.8	44.0
PP 27	1,440	30.2	46.9
PP 28	1,440	33.8	51.2
PP 29	1,440	36.2	54.1
PP 30	1,440	39.9	58.4
PP 31	1,440	49.2	64.2
PP 32	1,440	53.7	69.9
SS 18	1,440	59.2	81.4
SS 19	1,440	66.2	91.5
SS 20	720	38.6	57.0
SS 21	720	42.9	62.0
SS 22	720	46.5	66.3
SS 24	720	61.1	79.3
SS 26	360	40.5	59.1
SS 28	360	48.0	68.1
SS 29	288	47.4	71.9
SS 30	288	38.6	75.5
SS 34	144	30.2	62.1
SS 35	144	36.4	65.6
SS 38	144	44.7	73.6
SS 39	144	52.9	74.7
SS 40	144	47.1	81.5
SS 45	144	86.5	129.7
SS 48	144	118.5	169.0
SS 50	144	142.8	199.3
SS 55	72	96.5	135.7
25 mm	8	75.2	111.4
50 mm	2	127.1	181.5

# ROUND STONES

Article Size	Packing Unit = Minimum Order Quantity in Pieces	Average Net Weight in Grams per Packing Unit Crystal (001)	Average Gross Weight in Grams per Packing Unit Crystal (001)
<b>1122</b>			
SS 17	1,440	48.7	57.2
SS 24	720	47.0	66.9
SS 29	720	77.6	103.4
SS 34	360	58.5	80.6
SS 39	144	37.1	55.2
SS 47	288	158.6	215.9
12 mm	144	99.5	142.2
14 mm	144	167.4	225.9
16 mm	144	242.7	317.2
18 mm	72	181.7	244.0
<b>1128</b>			
PP 32	1,440	57.9	79.9
SS 29	360	53.5	74.6
SS 39	144	49.5	69.9
<b>1188</b>			
SS 17	1,440	53.4	62.3
SS 24	720	73.7	82.9
SS 29	288	52.1	66.4
SS 39	144	58.3	120.6
<b>1201</b>			
27 mm	24	174.3	245.6
35 mm	6	70.6	115.5
<b>1318</b>			
30 mm	24	373.8	723.0
55 mm	10	892.3	1,372.1
<b>1357</b>			
SS 17	720	26.9	42.9
SS 29	360	54.3	75.6
SS 39	144	52.1	73.0
20 mm	30	148.4	383.0
50 mm	12	1,006.2	1,482.0
80 mm	4	1,078.3	1,760.0
<b>1681</b>			
12 mm	72	56.8	101.3
16 mm	48	84.5	127.3
<b>1695</b>			
10 mm	72	48.4	79.6
14 mm	36	61.4	102.7